



Product Specification

Ningbo East Electronics Limited
NO. 88 East Jinhui Road, Yinzhou Ningbo 315100, P.R.China
<http://www.east-mingtao.com>

Product Name:	Magnetic Transducer
Part Number:	EMX-8T06P
Version:	1.02
Date:	2019-11-4
Note:	

East is an ISO 9001 , IATF16949 and ISO 14001 Certified Company

Revision History

Rev.	Description	Author/Date	Checked By	Approver
1.02	Quality management system revised	汤礼东 2019-11-4	吕文斌	王建成
1.01	Quality Certificate Symbol revised	吕文斌 2015-2-5	汤礼东	王建成
1.0	Released	汤礼东 2012-3-17	陈启旺	王建成

1. Part Number EMX-8T06P

2. Dimension Drawing (Unit: mm)

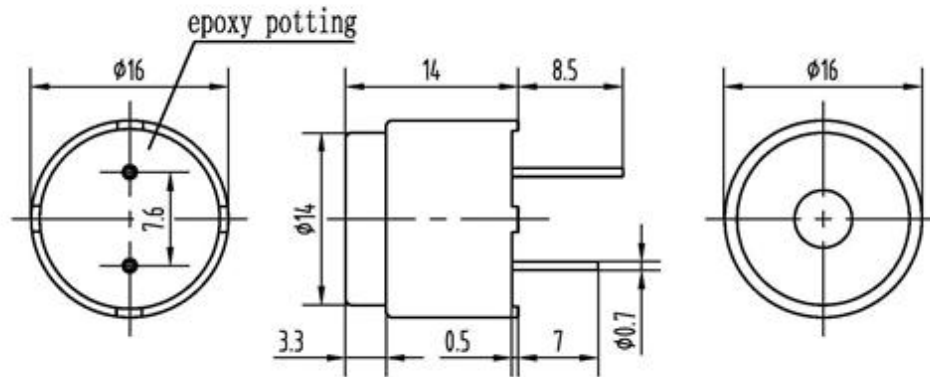

3. Specification

No.	Item	Specification
3-1	Min. Sound Pressure Level	85dB/2048Hz/6V /10cm
3-2	Rated Voltage	6V
3-3	Operating Voltage	4~8V
3-4	Max. Consumption (At 6V _{DC})	40mA/2048Hz/12Vp-p square wave
3-5	Resonant Frequency	2048Hz
3-6	Coil Resistance	50±5Ω
3-7	Coil Impedance	110Ω
3-8	Operating Temperature	-25~+70°C
3-9	Storage Temperature	-30~+85°C
3-10	Weight	5g
3-11	Pin Strength	More than 10N

NOTES:

- 1、 Value applying rated voltage(resonant frequency,1/2duty,square wave)
- 2、 Test should be made under the conditions of room temperature (20±10°C), normal humidity (60±20%) and normal atmospheric pressure. In this case, however, that the judgment is questionable, the test conditions are to be changed to room temperature 20±2°C, relative humidity 60~70% and normal atmospheric pressure

4. Typical Frequency Response Curve

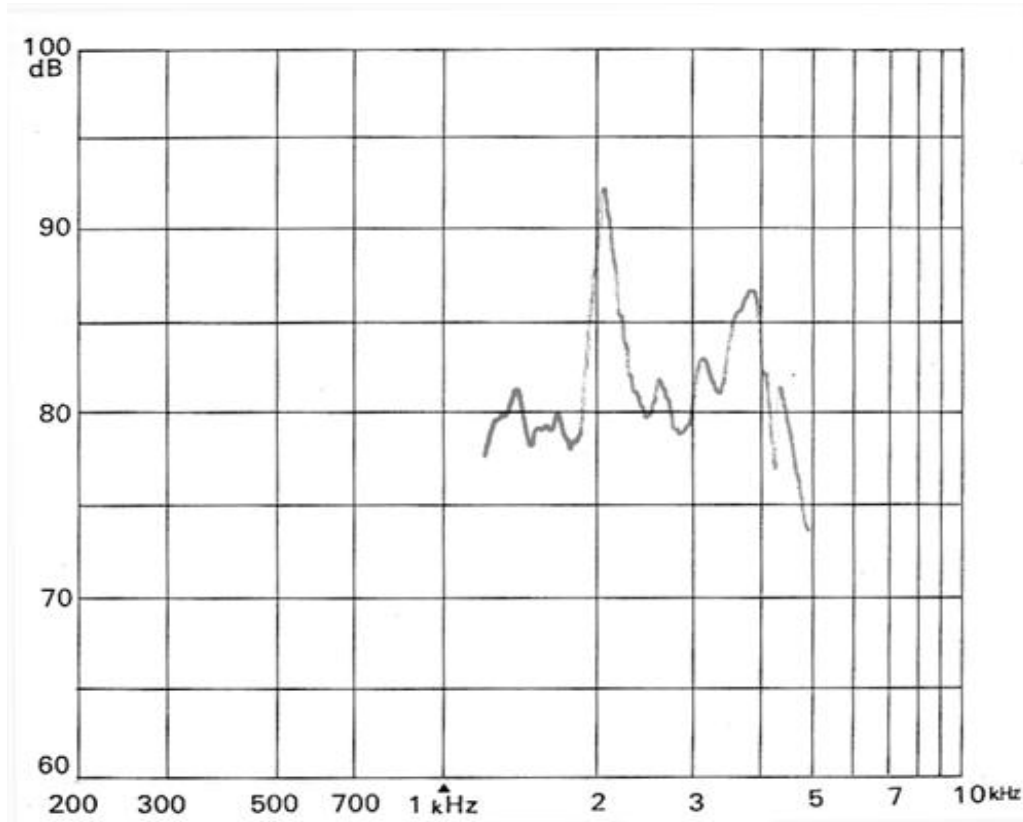

Note: Input Voltage 6V
Distance 10 cm

5. Reliability Test

No.	Item	Method of Test	Tolerance after Testing
5-1	Operating Temperature	-25~+70°C	Sound pressure level initial value ± 10 dB Max. consumption value $\pm 20\%$
5-2	Storage in high temperature	Storage in +85°C test box 96 hours then exposed to the room temperature for 2 hours	
5-3	Storage in low temperature	Storage in -30°C test box 96 hours then exposed to the room temperature for 2 hours	
5-4	Life test in the room temperature	Operate the product continuously 5 seconds on 5 seconds off 300 hours at rated voltage	
5-5	Temperature / humidity cycle test	Storage in +40°C, 93 \pm 3%RH test box 96 hours then exposed to the room temperature for 2 hours	
5-6	Temperature (high and low) cycle test	Conduct the test for 5 cycles without applying power then expose to the room temperature for 2 hours.(See Figure 5-6)	

5-7	Vibration test	Conduct the test for the directions of X Y and Z for 0.5 hour each (total 1.5 hours). To-and Fri sweep time(from 10 to 55Hz and then 55 to 10) under single amplitude of 0.75mm is 3 minute, then expose to the room temperature for 2 hours	
5-8	Drop test	Drop a product naturally from the height of 700mm onto the surface of 100mm thick wooden board. Two directions: upper and side of the product are to be applied for this drop test once respectively	
5-9	Soldering heat resistance test	Dip the connecting pins in soldering at $260\pm 5^{\circ}\text{C}$ for 10 ± 1 seconds	
5-10	Test of soldering	Dip the connecting pins in soldering at $230\pm 5^{\circ}\text{C}$ for 3 ± 0.5 seconds	Solder shall be attached around over 95% of the dipped portion
NOTE: The pins are allowed to deform after drop test.			

Figure 5-6

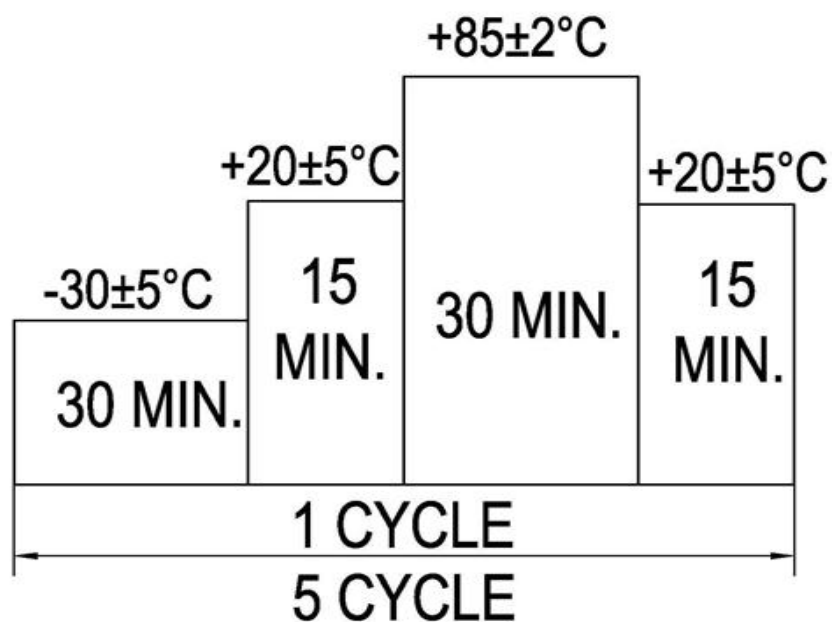

6. Electrical Testing Method

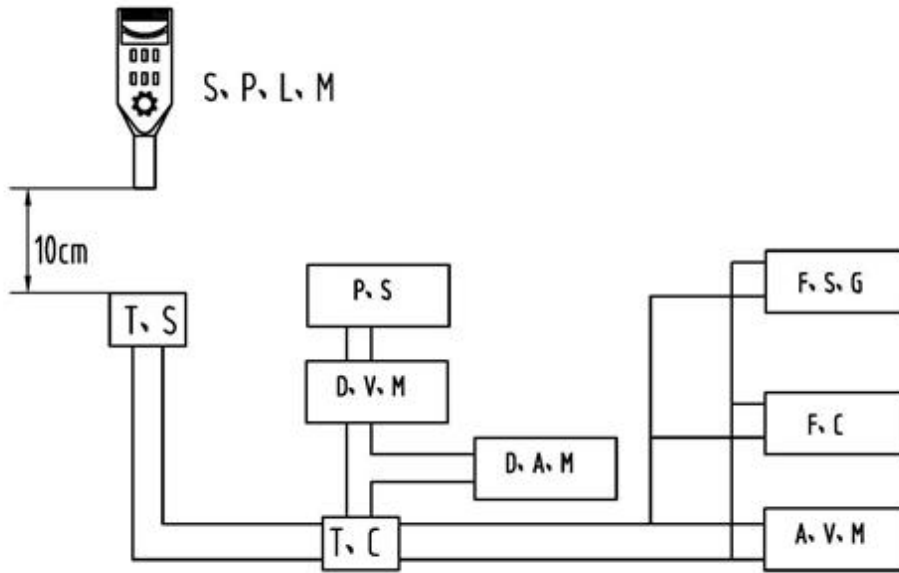

S.P.L.M	Sound Pressure Level Meter
T.S	Testing Sample
F.C	Frequency Counter
T.C	Test Circuit
F.S.G	Frequency Signal Generator
A.V.M	AC Voltage Meter
P.S	Power Supply
D.V.M	DC Voltage Meter
D.A.M	DC Ampere Meter

TC:

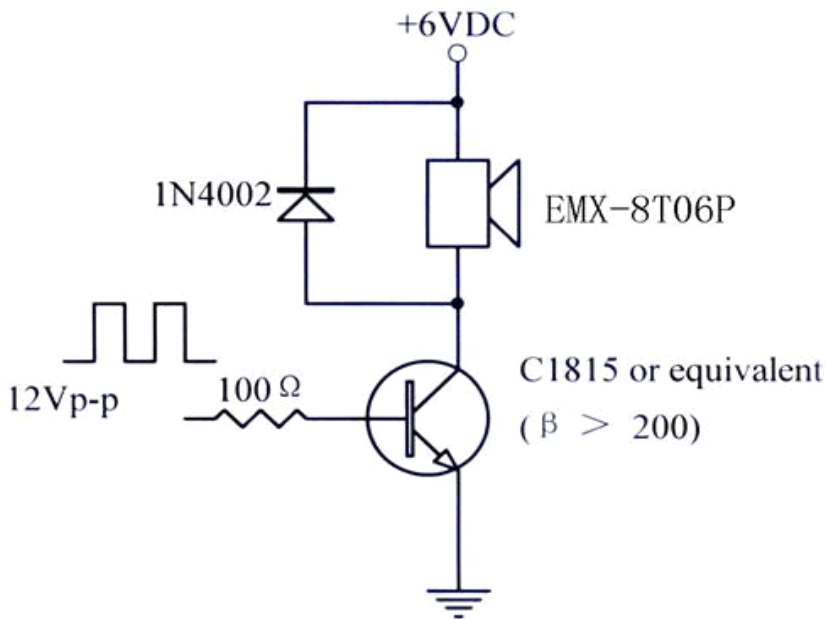

7. Packing Information

Packing: 900 pcs per export carton

Carton Size: 47× 25× 23 cm

G. Weight: 6.0 kgs N. Weight: 4.5 kgs